

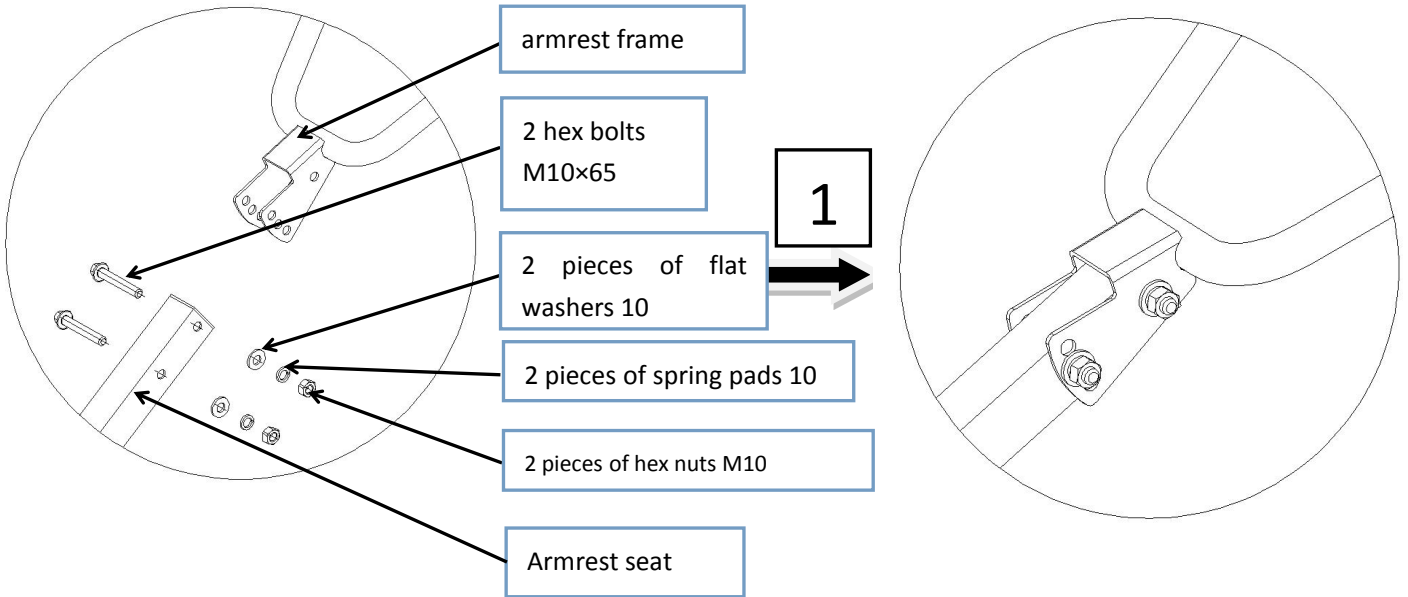

# HMTB55 QUICK ASSEMBLY GUIDE

1. Assemble the armrest frame to the armrest seat as shown in the figure and fasten it with bolts.



2. Assemble the connecting frame to the opening of the trailer body and fix it with the trailer body latch and R pin  $\phi 3 \times 20 \times 60$ , and then put the resistance tiller in the connecting frame knife box and use the B-type pin  $8 \times 30$  and R pin  $\phi 2 \times 9 \times 38$  to fix.

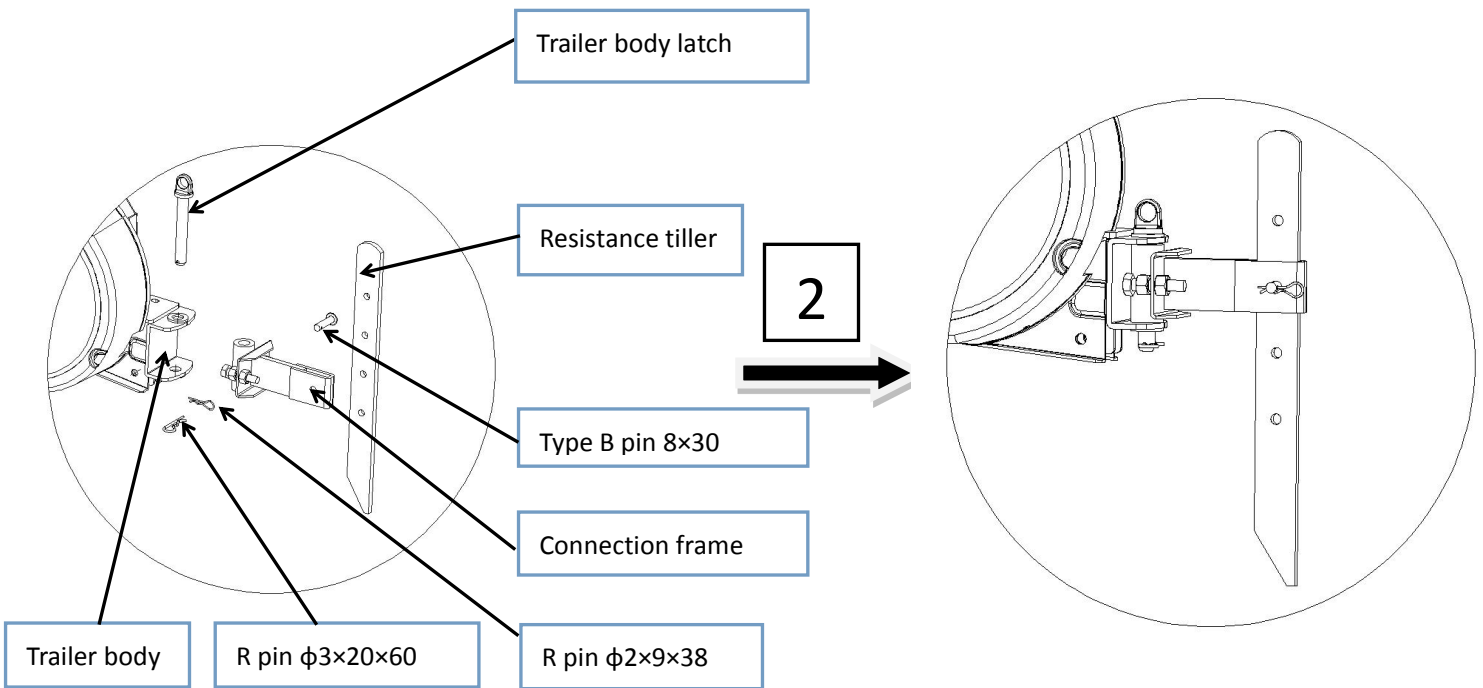

**3. Place the walking wheel assembly and the walking wheel tension spring between the power supports and use two B-type, two-piece B-type pin shafts 10×45, 4 large washers 10×2.5, and two R pins  $\phi 2 \times 9 \times 38$ , fixed as shown in the figure.**

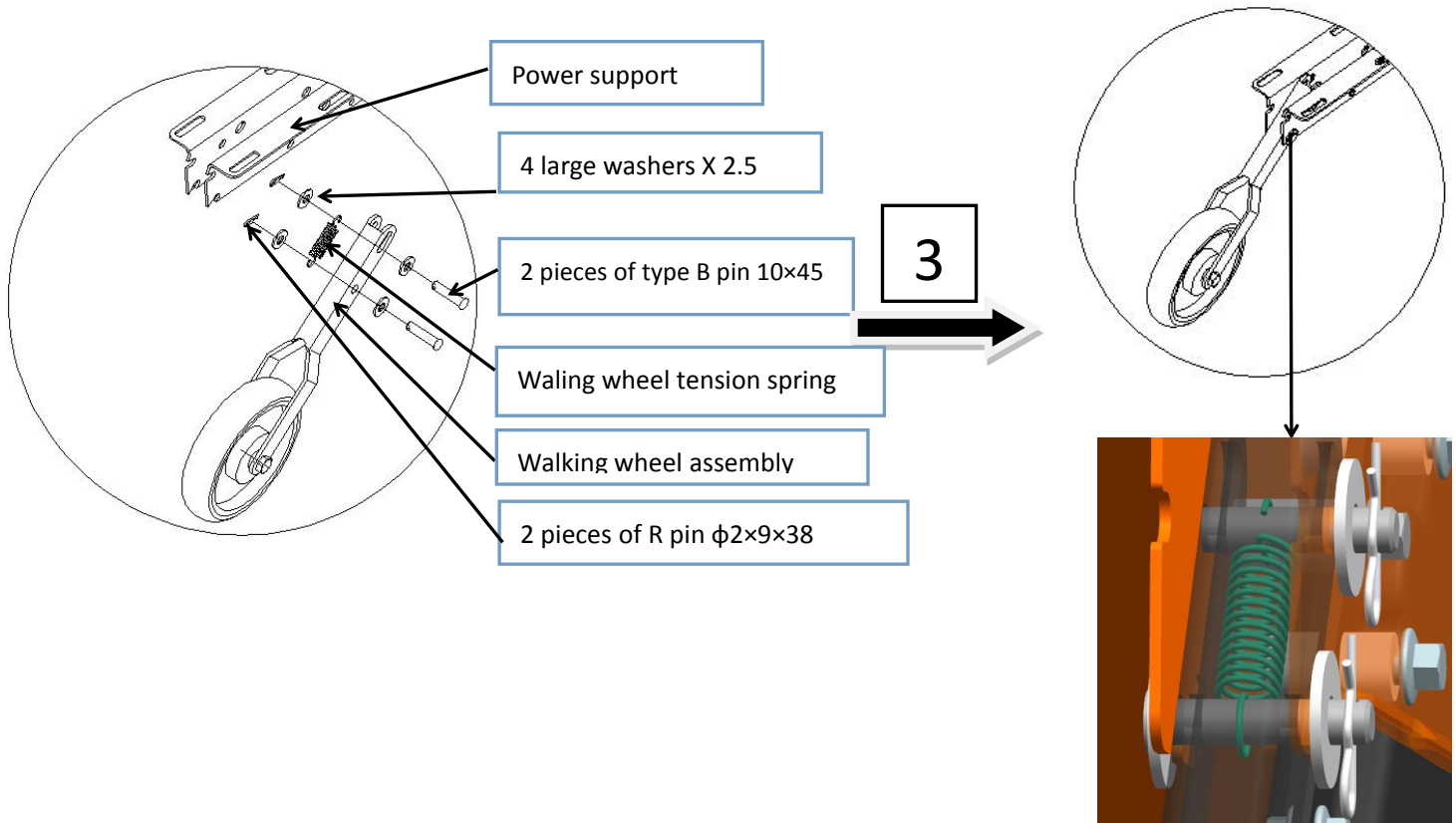

**4. Place the left and right fenders on the left and right sides of the inner fender as shown in the figure and fix them with 6 flange bolts M5×12 and 6 hexagon flange nuts M5.**

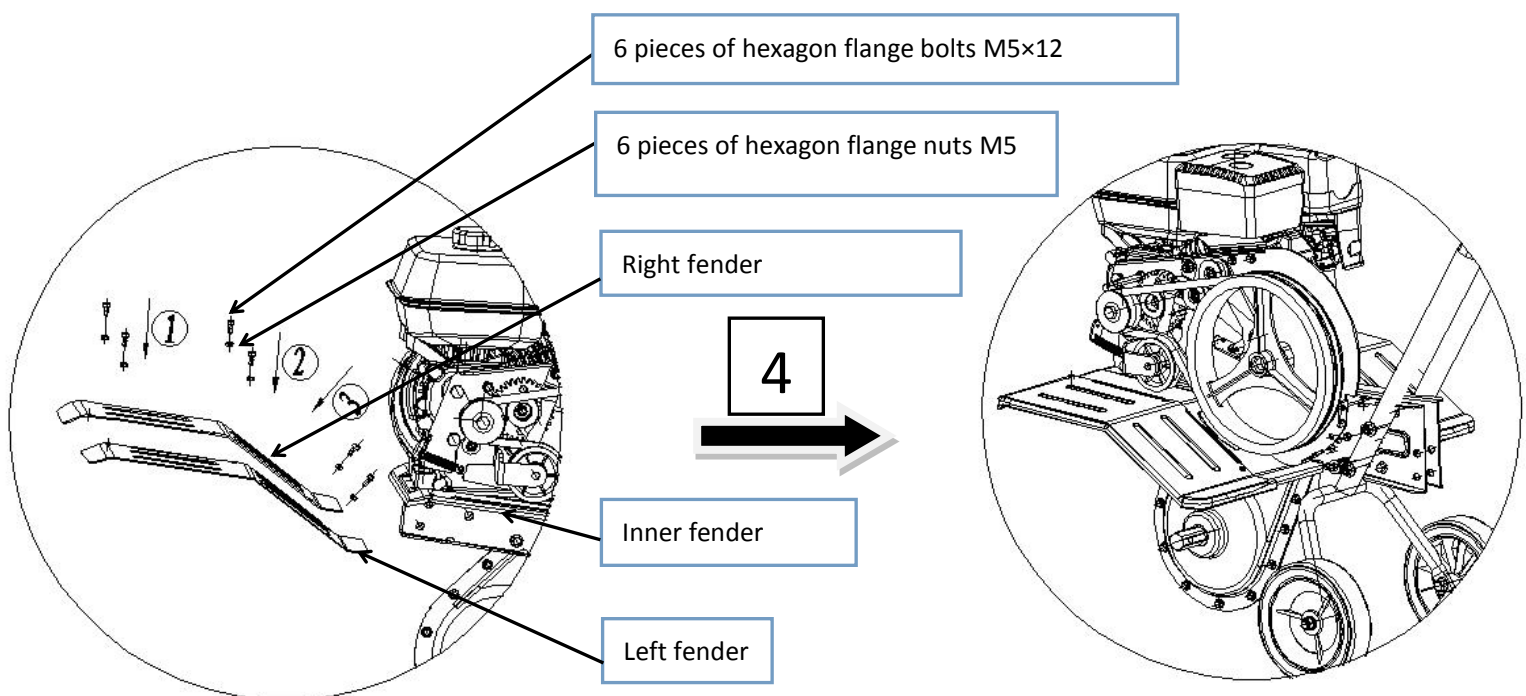

**5. Assemble the belt guard to the bottom of the belt guard and fix it with M5X12.**

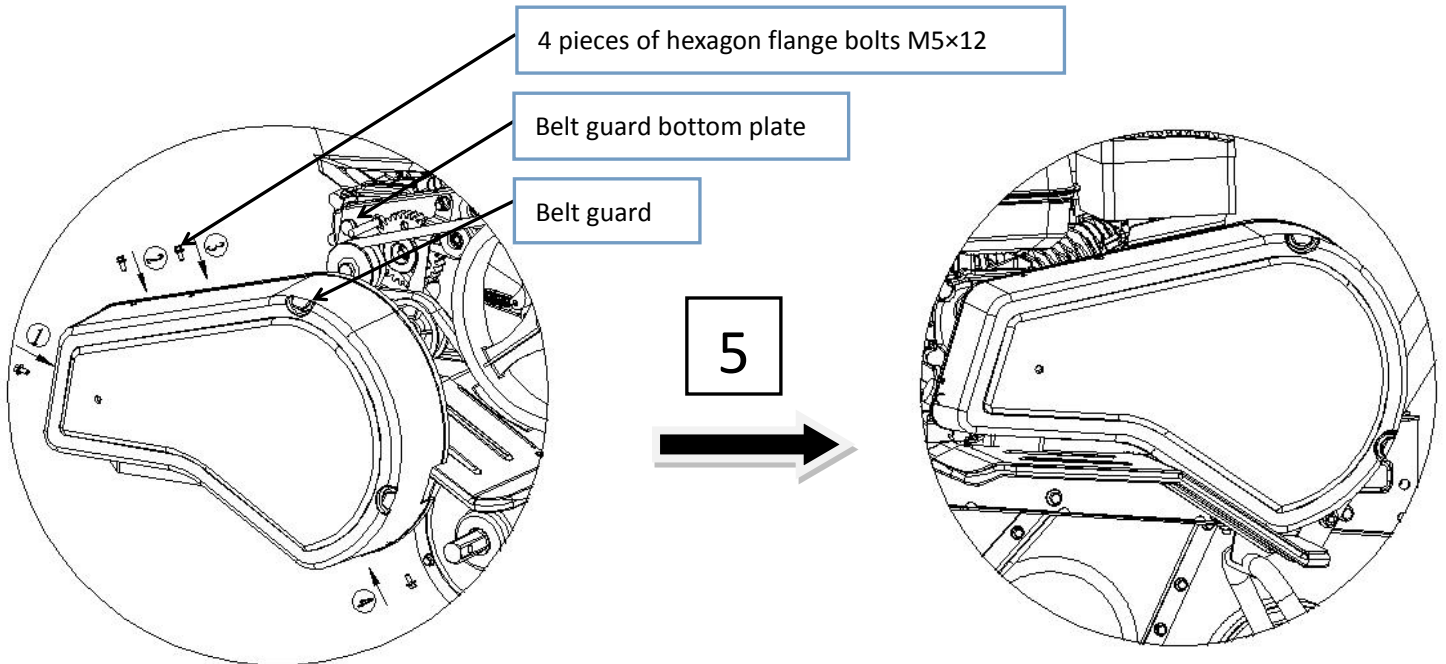

Assemble the cutter: As shown in the figure, install the blade on the main and auxiliary cutter barrels with bolts, and finally connect the main and auxiliary cutter barrel pins with the R pin; follow the previous steps to install the tool assembly, pay attention to the left and right tools The blades of the assembly correspond to each other.

The left of blades assy

The right of blades assy

Series No./pcs

- 1 = 16
- 2 = 16
- 3 = 16
- 4 = 8
- 5 = 8
- 6 = 2

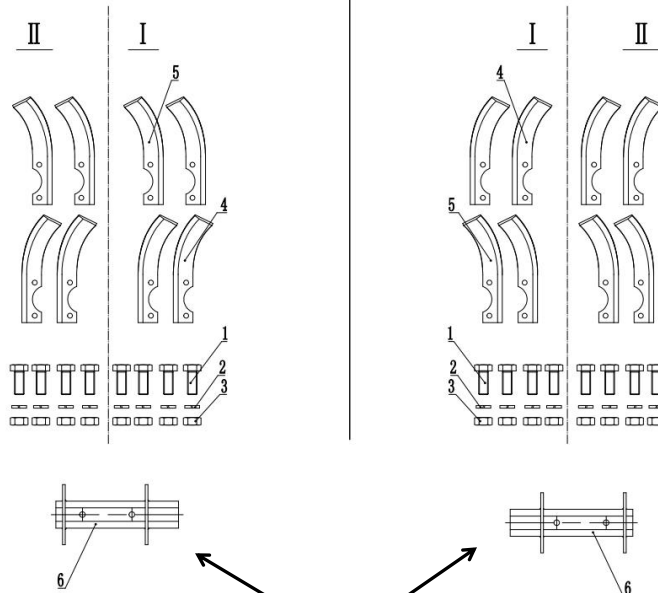

Main cutter barrel

Left cutter assembly

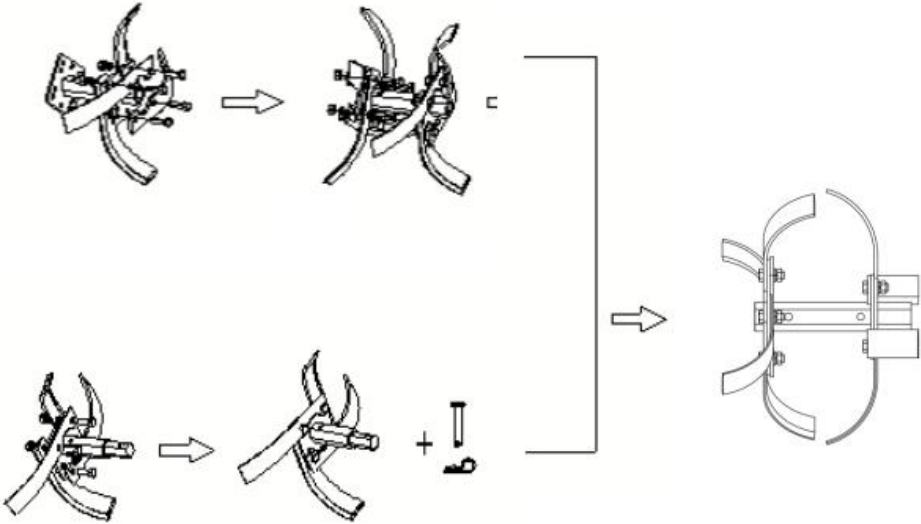

Right cutter assembly

